



3583

## High Voltage, High Current OPERATIONAL AMPLIFIER

### FEATURES

- WIDE POWER SUPPLY VOLTAGE:  
 $\pm 70V$  to  $\pm 150V$
- OUTPUT CURRENT TO 75mA
- SLEW RATE:  $30V/\mu s$
- FET INPUT:  $I_B = 20pA$  max
- THERMAL SHUT-DOWN PROTECTION
- HERMETIC TO-3 PACKAGE, ISOLATED CASE

### APPLICATIONS

- PROGRAMMABLE POWER SUPPLY
- PIEZO-ELECTRIC TRANSDUCER DRIVER
- HIGH VOLTAGE CURRENT SOURCE

### DESCRIPTION

The 3583 is a high voltage, high speed hybrid operational amplifier designed for a wide variety of programmable power supply and transducer driver applications.

The 3583 operates over a wide power supply range ( $\pm 50V$  to  $\pm 150V$ ) and provides outputs up to 75mA. Laser-trimmed FET input circuitry provides low offset voltage (3mV max) and low input bias current (20pA max). Thermal shut-down circuitry protects internal circuitry from excessive power dissipation.

Commercial and industrial temperature range models are available. The 3583's hermetic 8-pin TO-3 package is electrically isolated from all internal circuitry.

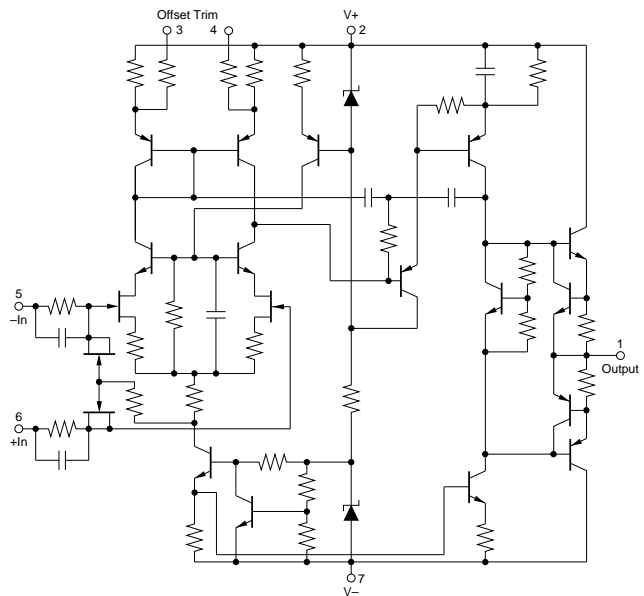

International Airport Industrial Park • Mailing Address: PO Box 11400 • Tucson, AZ 85734 • Street Address: 6730 S. Tucson Blvd. • Tucson, AZ 85706  
Tel: (520) 746-1111 • Twx: 910-952-1111 • Cable: BBRCORP • Telex: 066-6491 • FAX: (520) 889-1510 • Immediate Product Info: (800) 548-6132

# SPECIFICATIONS

## ELECTRICAL

T<sub>CASE</sub> = +25°C, V<sub>S</sub> = ±150V, unless otherwise noted.

PARAMETER	CONDITIONS	3583AM			3583JM			UNITS
		MIN	TYP	MAX	MIN	TYP	MAX	
<b>OFFSET VOLTAGE</b> Input Offset Voltage vs Temperature vs Power Supply vs Time	Specified Temp. Range		20 50	±3 ±23		* *	* *	mV μV/°C μV/V μV/month
<b>INPUT BIAS CURRENT<sup>(1)</sup></b> Input Bias Current vs Temperature vs Power Supply Input Offset Current vs Temperature vs Power Supply	V <sub>CM</sub> = 0V  V <sub>CM</sub> = 0V		Doubles Every 10°C 0.2  Doubles Every 10°C 0.2	-20  ±20		* *  * *	*  *	pA  pA/V pA pA/V
<b>NOISE</b> Voltage, 0.01Hz to 10Hz 10Hz to 1kHz Current, 0.01Hz to 10Hz			5 1.7 0.3			* * *		μVp-p μVrms pAp-p
<b>INPUT VOLTAGE RANGE</b> Max Safe Differential Input Max Safe Common-Mode Input Common-Mode Input Range Common-Mode Rejection	Linear Operation		(V+) +  V-  V- to V+ V <sub>S</sub> -10 110			* * * *		V dB
<b>INPUT IMPEDANCE</b> Differential Common-Mode			10 <sup>11</sup>    10 10 <sup>11</sup>			* *		Ω    pF Ω    pF
<b>OPEN-LOOP GAIN</b> Open-Loop Voltage Gain Open-Loop Voltage Gain	No Load, DC Rated Load, DC		118 105			* *		dB dB
<b>FREQUENCY RESPONSE</b> Unity-Gain Bandwidth Full-Power Bandwidth Slew Rate Settling Time: 0.1%	Small-Signal R <sub>L</sub> = 10kΩ		5 60 30 12			* * * *		MHz kHz V/μs μs
<b>OUTPUT</b> Voltage Output Current Output Short Circuit Current Load Capacitance		V <sub>S</sub> -10 ±75	±100	10		* *  *		V mA mA nF
<b>POWER SUPPLY</b> Operating Voltage Range Quiescent Current	I <sub>O</sub> = 0	±50		±150 ±8.5		*  *		V mA
<b>TEMPERATURE RANGE (CASE)</b> Specification Operating Storage θ <sub>JC</sub> = 4°C/W		-25 -55 -55		+85 +125 +125	0 * *		+70 * *	°C °C °C

\* Specification same as 3583AM.

NOTE: (1) Inputs may be damaged by input slew rates exceeding 1000V/μs. Inputs can be protected from signals exceeding 1000V/μs by limiting input current to 150mA with external series resistors (pins 5 and 6).

The information provided herein is believed to be reliable; however, BURR-BROWN assumes no responsibility for inaccuracies or omissions. BURR-BROWN assumes no responsibility for the use of this information, and all use of such information shall be entirely at the user's own risk. Prices and specifications are subject to change without notice. No patent rights or licenses to any of the circuits described herein are implied or granted to any third party. BURR-BROWN does not authorize or warrant any BURR-BROWN product for use in life support devices and/or systems.

## CONNECTION DIAGRAM

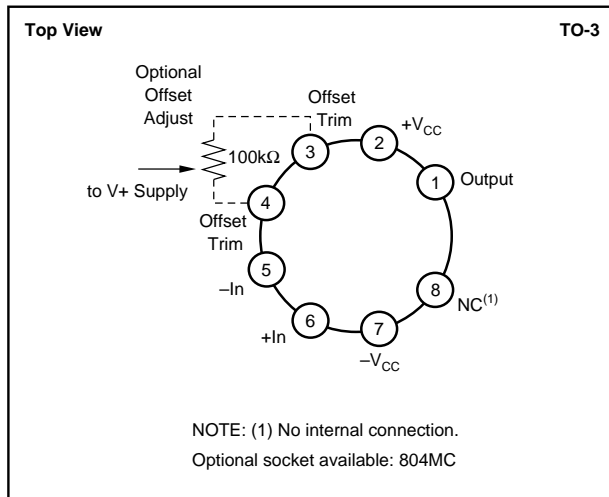

## PACKAGING INFORMATION

MODEL	PACKAGE	PACKAGE DRAWING NUMBER <sup>(1)</sup>
3583AM	8-Pin TO 3	030
3583JM	8-Pin TO 3	030

NOTE: (1) For detailed drawing and dimension table, please see end of data sheet, or Appendix D of Burr-Brown IC Data Book.

## ORDERING INFORMATION

MODEL	PACKAGE	TEMPERATURE RANGE
3583AM	8-Pin TO-3	-25°C to +85°C
3583JM	8-Pin TO-3	0°C to +70°C

## TYPICAL PERFORMANCE CURVES

T<sub>CASE</sub> = +25°C, ±V<sub>CC</sub> = 150VDC, unless otherwise noted.

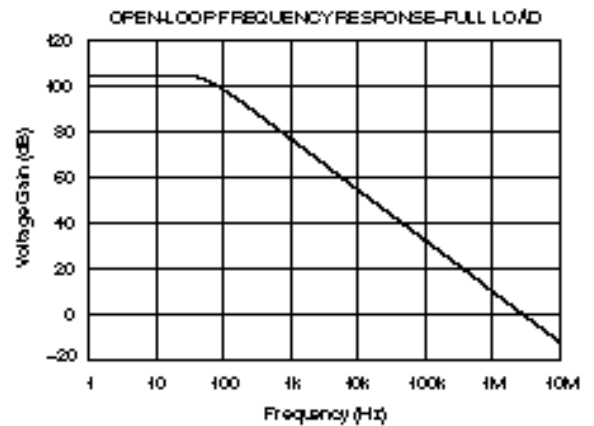
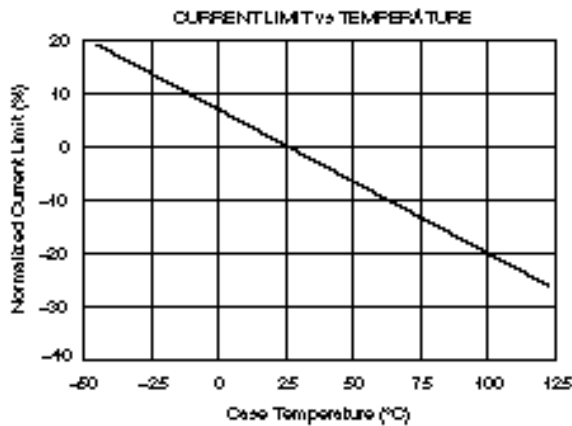
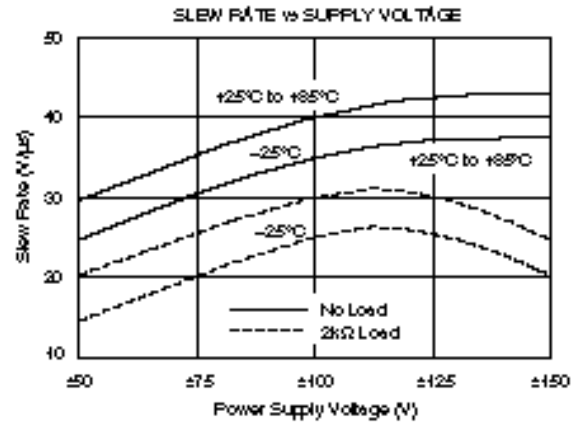
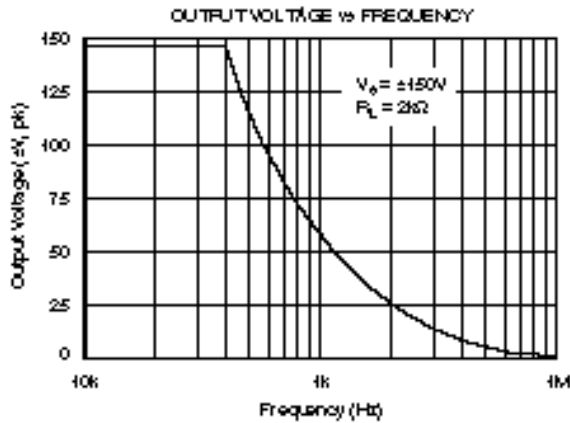

# TYPICAL PERFORMANCE CURVES

$T_{CASE} = +25^{\circ}C, \pm V_{CC} = 150VDC$ , unless otherwise noted.

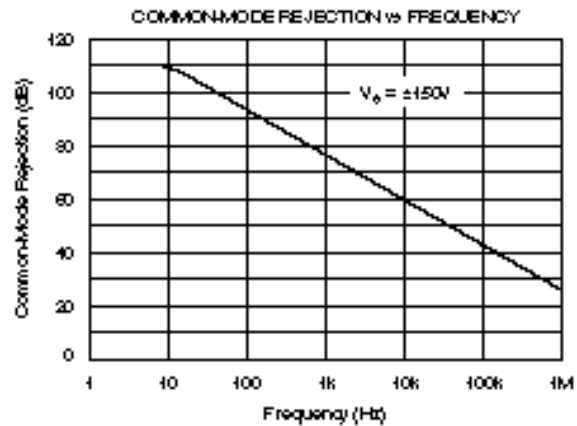
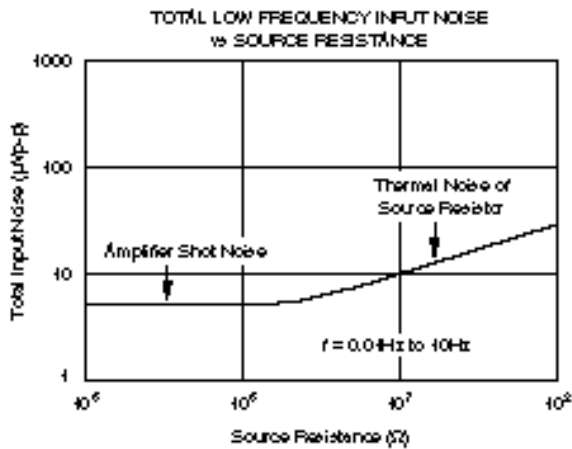
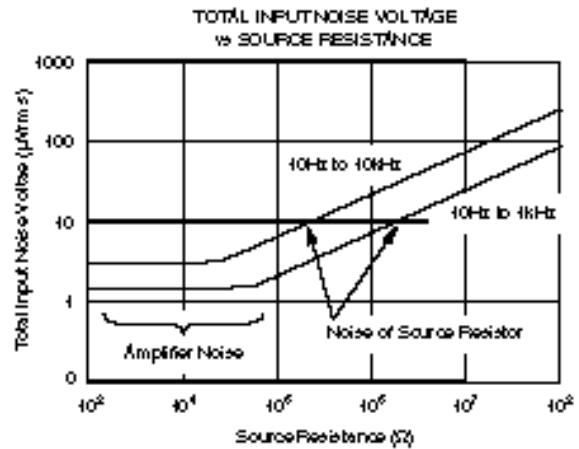
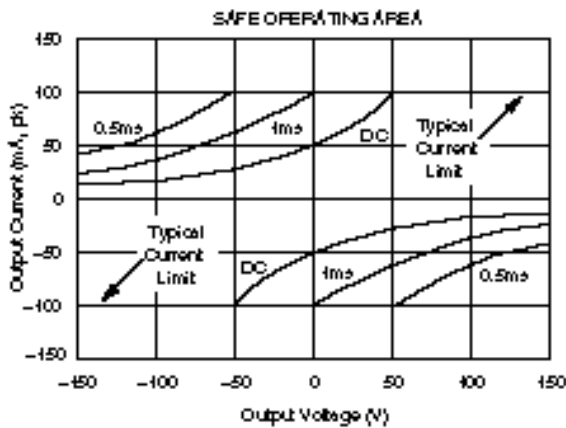
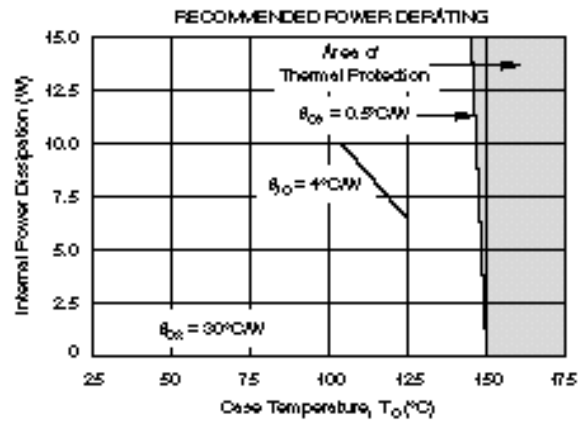
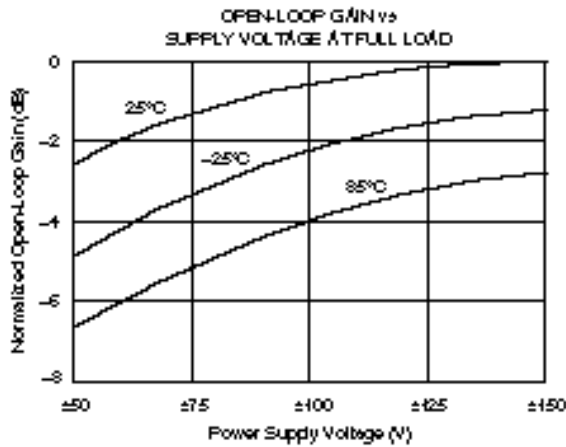

# TYPICAL PERFORMANCE CURVES (CONT)

T<sub>CASE</sub> = +25°C, ±V<sub>CC</sub> = 150VDC, unless otherwise noted.

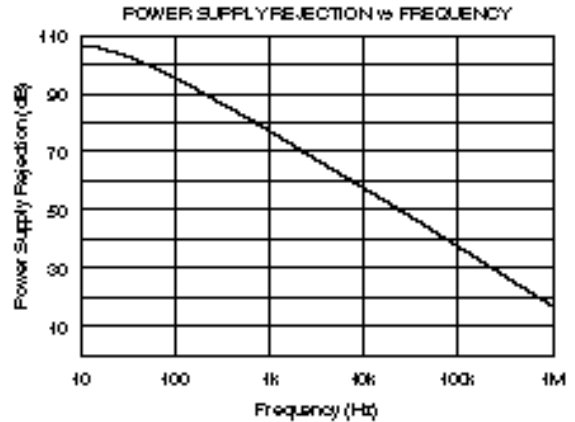
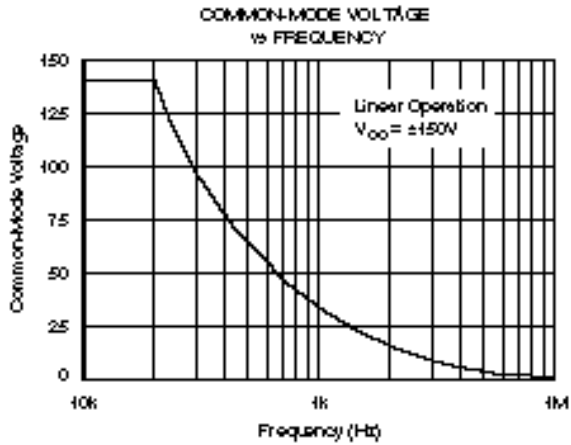

## APPLICATION INFORMATION

Figure 1 shows the basic connections required to operate the 3583. Power supply bypass capacitors should be connected close to the device pins. Be sure that these capacitors have an adequate voltage rating.

Input offset voltage and drift of the 3583 are laser-trimmed. Many applications require no external offset trimming. Figure 1 also shows connection of an optional offset trim potentiometer connected to pins 3 and 4.

FET input circuitry reduces the input bias current of the 3583 to less than 20pA at room temperature. Input bias current remains nearly constant throughout the full common-mode range. Input bias current approximately doubles for each 10°C increase in case temperature above 25°C. Heat sinking can help minimize this effect by reducing the case temperature.

Input circuitry of the 3583 is protected with series limiting resistors and input clamp diodes. The inputs can withstand the full rated supply voltage of ±150V (common-mode or differential).

### THERMAL PROTECTION

The 3583 has internal thermal shut-down circuitry that activates at a case temperature of approximately 150°C or higher. As this circuitry is activated, the output current drive is reduced. As the case temperature returns to less than the activation temperature, operation will return to normal. A heat sink may be required depending on load and signal conditions.

Note that a 75mA output may not be safe for all output voltages—see typical performance curve “Safe Operating Area”. Applications such as current sources where output voltage may be low (or the opposite polarity of the output current) can overstress the output stage.

The thermal shut-down circuit will normally protect the amplifier during a short-circuit to ground. It will not protect against short-circuit to one of the power supplies. The typical performance curve “Safe Operating Area” shows that the large stress occurring during this high voltage condition may cause damage if it exceeds 5ms duration. The thermal protection circuitry will not activate fast enough to protect the device from short-circuits to one of the power supplies.

The package case of the 3583 is electrically isolated from all circuitry. No special insulating hardware is required. Although not absolutely required, it is recommended that the case be connected to ground.

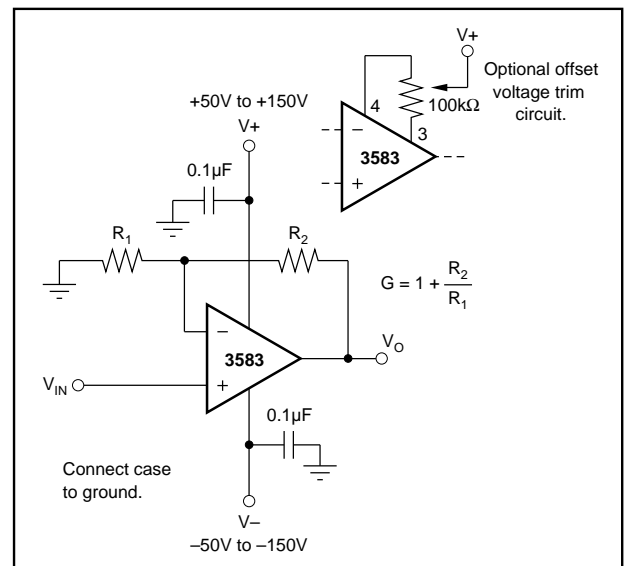

FIGURE 1. Basic Circuit Connections.

---

## PACKAGING INFORMATION

ORDERABLE DEVICE	STATUS(1)	PACKAGE TYPE	PACKAGE DRAWING	PINS	PACKAGE QTY
3583JM	NRND	TO/SOT	LMF	8	18

(1) The marketing status values are defined as follows:

**ACTIVE:** Product device recommended for new designs.

**LIFEBUY:** TI has announced that the device will be discontinued, and a lifetime-buy period is in effect.

**NRND:** Not recommended for new designs. Device is in production to support existing customers, but TI does not recommend using this part in a new design.

**PREVIEW:** Device has been announced but is not in production. Samples may or may not be available.

**OBSOLETE:** TI has discontinued the production of the device.

---

## IMPORTANT NOTICE

Texas Instruments Incorporated and its subsidiaries (TI) reserve the right to make corrections, modifications, enhancements, improvements, and other changes to its products and services at any time and to discontinue any product or service without notice. Customers should obtain the latest relevant information before placing orders and should verify that such information is current and complete. All products are sold subject to TI's terms and conditions of sale supplied at the time of order acknowledgment.

TI warrants performance of its hardware products to the specifications applicable at the time of sale in accordance with TI's standard warranty. Testing and other quality control techniques are used to the extent TI deems necessary to support this warranty. Except where mandated by government requirements, testing of all parameters of each product is not necessarily performed.

TI assumes no liability for applications assistance or customer product design. Customers are responsible for their products and applications using TI components. To minimize the risks associated with customer products and applications, customers should provide adequate design and operating safeguards.

TI does not warrant or represent that any license, either express or implied, is granted under any TI patent right, copyright, mask work right, or other TI intellectual property right relating to any combination, machine, or process in which TI products or services are used. Information published by TI regarding third-party products or services does not constitute a license from TI to use such products or services or a warranty or endorsement thereof. Use of such information may require a license from a third party under the patents or other intellectual property of the third party, or a license from TI under the patents or other intellectual property of TI.

Reproduction of information in TI data books or data sheets is permissible only if reproduction is without alteration and is accompanied by all associated warranties, conditions, limitations, and notices. Reproduction of this information with alteration is an unfair and deceptive business practice. TI is not responsible or liable for such altered documentation.

Resale of TI products or services with statements different from or beyond the parameters stated by TI for that product or service voids all express and any implied warranties for the associated TI product or service and is an unfair and deceptive business practice. TI is not responsible or liable for any such statements.

Following are URLs where you can obtain information on other Texas Instruments products and application solutions:

<b>Products</b>		<b>Applications</b>	
Amplifiers	<a href="http://amplifier.ti.com">amplifier.ti.com</a>	Audio	<a href="http://www.ti.com/audio">www.ti.com/audio</a>
Data Converters	<a href="http://dataconverter.ti.com">dataconverter.ti.com</a>	Automotive	<a href="http://www.ti.com/automotive">www.ti.com/automotive</a>
DSP	<a href="http://dsp.ti.com">dsp.ti.com</a>	Broadband	<a href="http://www.ti.com/broadband">www.ti.com/broadband</a>
Interface	<a href="http://interface.ti.com">interface.ti.com</a>	Digital Control	<a href="http://www.ti.com/digitalcontrol">www.ti.com/digitalcontrol</a>
Logic	<a href="http://logic.ti.com">logic.ti.com</a>	Military	<a href="http://www.ti.com/military">www.ti.com/military</a>
Power Mgmt	<a href="http://power.ti.com">power.ti.com</a>	Optical Networking	<a href="http://www.ti.com/opticalnetwork">www.ti.com/opticalnetwork</a>
Microcontrollers	<a href="http://microcontroller.ti.com">microcontroller.ti.com</a>	Security	<a href="http://www.ti.com/security">www.ti.com/security</a>
		Telephony	<a href="http://www.ti.com/telephony">www.ti.com/telephony</a>
		Video & Imaging	<a href="http://www.ti.com/video">www.ti.com/video</a>
		Wireless	<a href="http://www.ti.com/wireless">www.ti.com/wireless</a>

Mailing Address: Texas Instruments  
Post Office Box 655303 Dallas, Texas 75265

Copyright © 2003, Texas Instruments Incorporated